

### Introduction to Rotating Machines

- The rotor and stator each consist of a magnetic core, some electrical insulation, and the windings necessary to establish a magnetic flux (unless it is created by a permanent magnet).
- The rotor is mounted on a bearing supported shaft, which can be connected to mechanical loads (motor) or to a primer mover (generator), by means of belts, pulleys or other mechanical couplings.
- The basic electrical machine creates two magnetic fields. One on the rotor and one on the stator. The field of the rotor will seek to align with the field of the stator, thereby creating torque and rotation.

### Introduction to Rotating Machines

The windings carry the electrical currents that generate the magnetic fields and that flow to the electrical loads.

If the current serves the sole purpose of providing a magnetic field and is independent of the load, it is called a magnetizing, or exciting current. The winding in which it flows is called a field winding.

If the windings carry the load current, it is called the armature winding or armature.

### Introduction to Rotating Machines

Machine Type	Winding Purpose	Winding Type	Location	Current Type
DC Machine	In/Out	Armature	Rotor	AC->DC
	Excitation	Field	Stator	DC
AC Synchronous	In/Out	Armature	Stator	AC
	Excitation	Field	Rotor	DC
AC Induction	Input	Primary	Stator	AC
	Output	Secondary	Rotor	AC

## Introduction to Rotating Machines

**Generator :** A machine that converts mechanical energy from a prime mover to electrical energy.

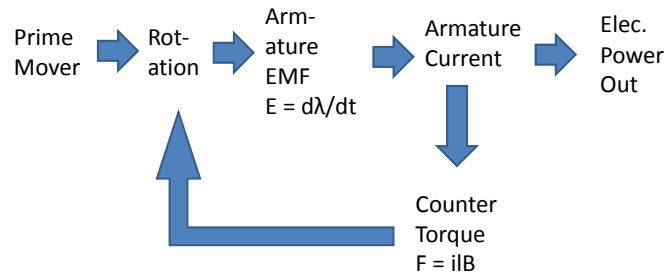

## Introduction to Rotating Machines

**Generator:** A machine that converts mechanical energy from a prime mover to electrical energy.

Power flow and losses in DC generator

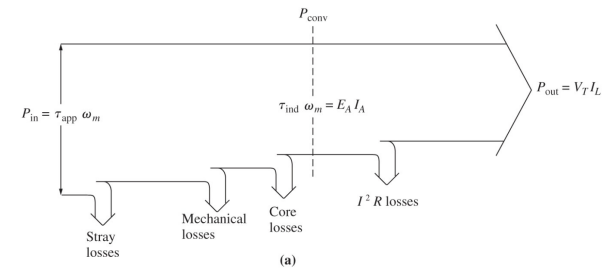

## Introduction to Rotating Machines

**Motor :** A machine that converts electrical energy from a source to mechanical energy.

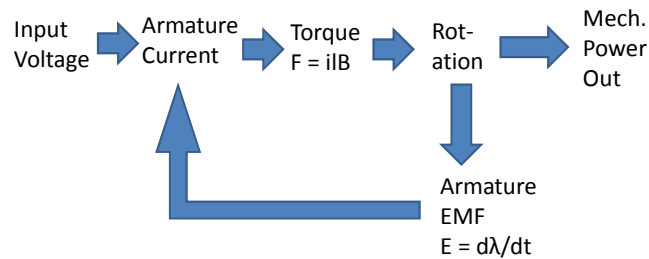

## Introduction to Rotating Machines

**Motor:** A machine that converts electrical energy from a source to mechanical energy.

Power flow and losses in DC motor

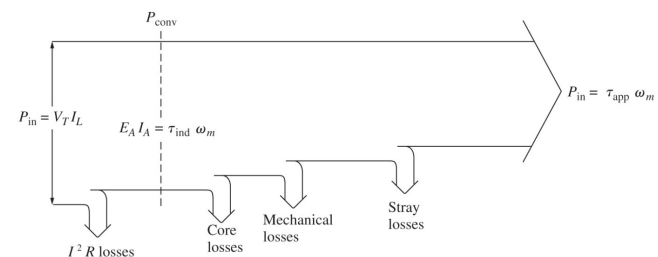

### Introduction to Rotating Machines

In a generator the prime mover causes the rotation and the commutator serves to rectify voltage at the brushes.

Rectification occurs when the rotor winding experience minimum flux.

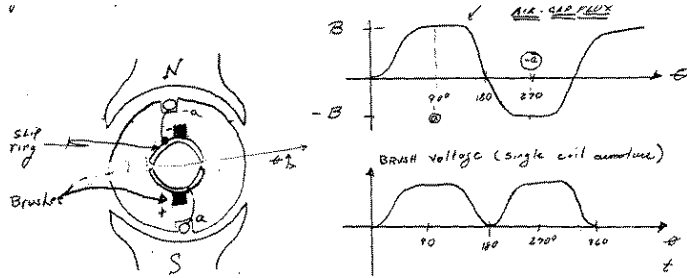

### Introduction to Rotating Machines

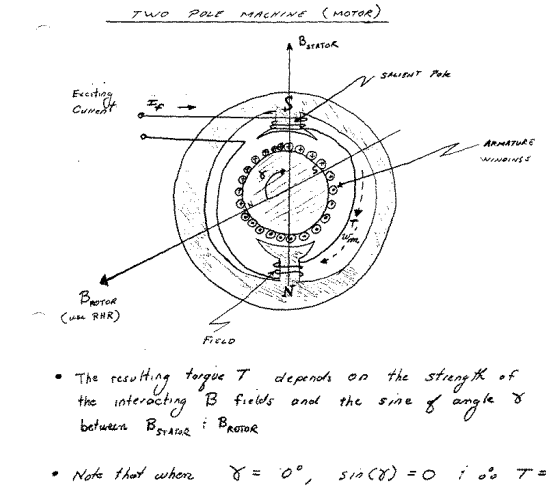

### Introduction to Rotating Machines

#### How to keep the rotor turning.

- In order to prevent the rotor from stopping for  $\gamma = 0^\circ$  which implies alignment of  $B_{stator}$  and  $B_{rotor}$  two schemes are possible.
- Supply the stator windings with an alternating current causing it's  $B_{stator}$  field to change direction periodically. Thus preventing the rotor field from aligning with that of the stator. This is how an AC synchronous machine works.

### Introduction to Rotating Machines

#### How to keep the rotor turning.

- Supply the rotor winding with an alternating current causing  $B_{rotor}$  to change direction periodically. The reversal is accomplished by the commutator assembly attached to the rotor.
- Since the torque is a maximum for  $\gamma = 90^\circ$ , the commutator is configured so that the current distribution in the rotor windings remain constant and the rotor poles are always at  $90^\circ$  with respect to the fixed stator poles.

### Introduction to Rotating Machines

*D. Commutator Action*

As the commutator rotates CCW with the rotor, the magnetic field  $B_r$  also rotates CCW. After  $\theta = 30^\circ$ , a new segment pair will be connected to the brushes. The current through winding coils L3 and L6 will reverse direction and the rotor magnetic field will shift by  $60^\circ$  in the direction opposite to rotation (CW).

### Introduction to Rotating Machines

*D. Commutator Action*

As the commutator continues to rotate, the magnetic field  $B_{rotor}$  will change from  $-30^\circ$  to  $+30^\circ$ . Then a new segment pair will be connected to the brushes and the rotor magnetic field will again shift by  $60^\circ$  in the CW direction.

### Introduction to Rotating Machines

In this machine, the torque angle (between  $B_{stator}$  and  $B_{rotor}$ ) is not always the ideal value of  $90^\circ$ , but actually varies from  $60^\circ$  to  $120^\circ$  as the machine rotates. The resulting torque will vary by up to 14%  $\{\sin(90^\circ - 30^\circ) = 0.86\}$  from the maximum value.

As the number of segments are increased, the torque fluctuations produced by commutation will be reduced. For example, with 60 segments the torque angle will vary from  $90^\circ$  by  $\pm 3^\circ$ . The resulting torque will vary by only 0.5% from the maximum value.

In this way a DC motor can produce nearly constant torques and DC generators can produce nearly constant voltages.

### Introduction to Rotating Machines

- ARMATURE REACTION (AR)**

The mmf produced in the armature windings effects the spatial distribution of the air gap flux and the magnitude of the net flux per pole.

The effect of armature reaction is to create flux crossing the main field flux. This is called cross magnetizing armature reaction, or just armature reaction.

Armature reaction causes a decrease in the air gap flux under part of the pole face and an increase under the other part of the pole. Because of magnetic saturation of the machine iron, the net flux is decreased by a greater amount. Thus the net flux per pole is less than that produced by the field windings alone.

### Armature Reaction Effects

- The effect of the *magnetic flux generated by the armature current* on the *main magnetic field* of the machine is called *armature reaction*.
- Shift in the *magnetic neutral plane*: arching and sparking at the brushes when machine is loaded.

17

Figure 7-23  
The development of armature reaction in a dc machine.

Copyright © The McGraw-Hill Companies, Inc. Permission required for reproduction or display.

### Armature Reaction Effects

- The *flux-weakening* caused by the armature reaction.

18

Copyright © The McGraw-Hill Companies, Inc. Permission required for reproduction or display.

### Introduction to Rotating Machines

- ARMATURE REACTION**  
Quantitatively, the effect of AR is complex due to the non-linear behavior of machine saturation. Typically the effects of AR are determined experimentally, and are displayed via the machines magnetization curve.  
The effect on the net field is loosely proportional to the armature current Ia. Therefore, a family of mag. curves are drawn for a series of values of Ia. So for analysis purposes, the effect of AR can be accounted for simply by using the appropriate curve for the Ia in question.

### Introduction to Rotating Machines

- ARMATURE REACTION**  
In general the amount of AR increases proportional to Ia. Therefore, the result of AR is to shift the curve to the right for increasing Ia.

## Introduction to Rotating Machines

- ARMATURE REACTION**

AR can be reduced by design. It is beneficial to ensure that the main field is predominant in the air gap. Thus favor a strong field mmf and weak armature mmf as far as practical.

More elaborate designs will include pole face shaping, armature teeth shaping, additional windings (compensating windings) and additional poles (interpoles). All in an effort to counter the ill effects of AR.

## Solution to the Problems with Armature Reaction

- Brush shifting**

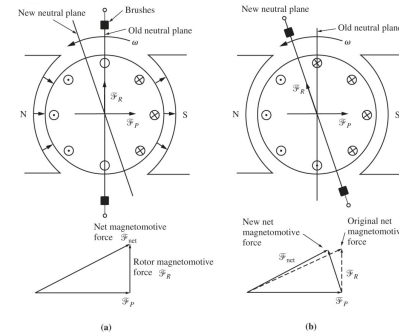

(a) The net mmf with brushes in the vertical position. (b) The net mmf with its brushes over the shifted neutral plane. Note that now there is a net opposing armature-reaction mmf.

22

Copyright © The McGraw-Hill Companies, Inc. Permission required for reproduction or display.

## Solution to the Problems with Armature Reaction

- Commutating Poles or Interpoles, are placed midway between main poles producing an mmf equal but opposite to the mmf of the armature reaction.

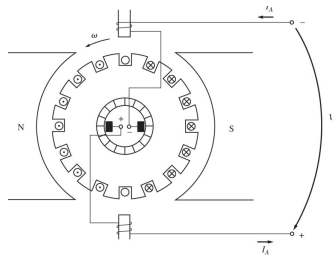

Figure 7-28  
A dc machine with interpoles.

23

Copyright © The McGraw-Hill Companies, Inc. Permission required for reproduction or display.

## Introduction to Rotating Machines

- Torque Speed Curve (Motor)**

The T-S characteristic of a motor describes how the torque supplied by the machine varies as a function of the speed of rotation of the motor.

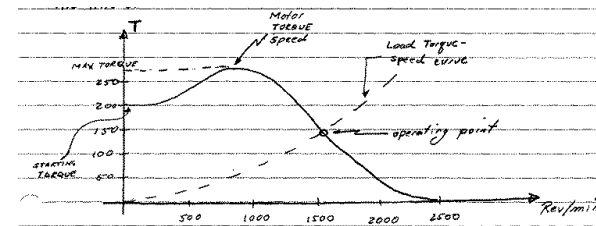

A motor is not an ideal source of torque (if it were the T-S curve would be horizontal line)